



# H 7809A

## Description

The H7809A series of three terminal positive Regulators are available in the TO-220 package and with several fixed output voltages, making them useful in a wide range of applications. Each type employs internal current limiting, Thermal shut down and safe operating area protection, making it essentially indestructible. If adequate heat sinking is provided, they can deliver over 1A output current. Although designed primarily as fixed voltage regulator, these devices can be used with external components to obtain adjustable voltages and currents.

## Features

- Output current up to 1A
- Output Voltages of 9V
- Thermal Overload Protection
- Short Circuit Protection
- Output Transistor Safe Operating Area Protection

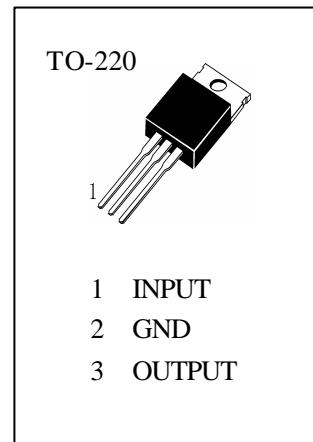

## Absolute Maximum Ratings ( $T_a=25^\circ\text{C}$ )

$V_I$	—Input Voltage (for $V_O=5\text{V}$ to $18\text{V}$ ).....	35V
$R_{JC}$	—Thermal Resistance Junction-Cases.....	5 $^\circ\text{C}/\text{W}$
$R_{JA}$	—Thermal Resistance Junction-Air.....	65 $^\circ\text{C}/\text{W}$
$T_{OPR}$	—Operating Temperature Range.....	0~125
$T_{STG}$	—Storage Temperature Range.....	-65~150

## Internal Block Diagram

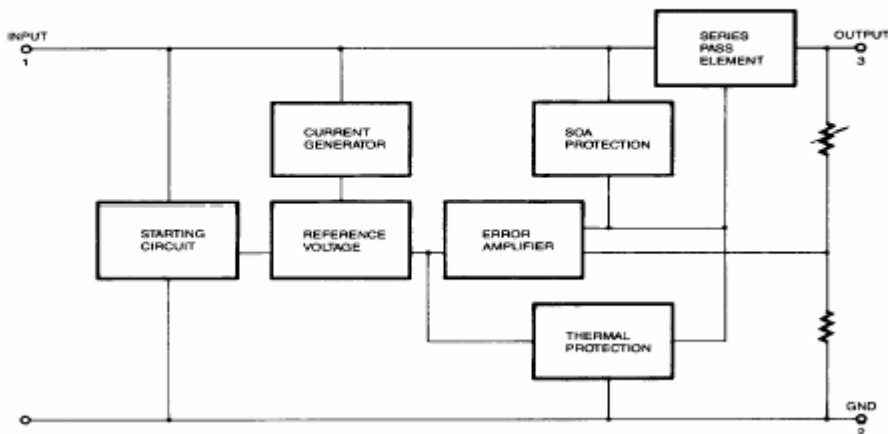



( Refer to test circuit, unless otherwise specified , 0  $T_J$  125 ,  $I_o=500mA$ ,  $V_i=15V$ ,  $C_i=0.33 \mu F$ ,  $C_o=0.1 \mu F$  )

Symbol	Parameter	Min.	Typ.	Max.	Unit	Conditions
$V_o$	Output Voltage	8.65	9.0	9.35	V	$T_J=25$
		8.6	9.0	9.4		$5.0mA \leq I_o \leq 1.0A$ , $P_o \leq 15W$ , $11.5V \leq V_i \leq 24V$
$V_o$	Line Regulation (Note1)		6.0	90	mV	$T_J=25$ , $11.5V \leq V_i \leq 24V$
			2.0	45		$T_J=25$ , $12.5V \leq V_i \leq 19V$
$V_o$	Load Regulation (Note1)		12	100	mV	$T_J=25$ , $5.0mA \leq I_o \leq 1.5A$
			5	50		$T_J=25$ , $250mA \leq I_o \leq 750mA$
$I_o$	Quiescent Current		5.0	8.0	mA	$T_J=25$
$I_o$	Quiescent Current Change			0.5	mA	$5mA \leq I_o \leq 1.0A$
				0.8		$12V \leq V_i \leq 25V$
$V_o/ T$	Output Voltage Drift		-1		mV/	$I_o=5mA$
$V_N$	Output Noise Voltage		58		$\mu V$	$T_A=25$ , 10Hz $f$ 100kHz
RR	Ripple Rejection	56	71		dB	$f=120Hz$ , $13V \leq V_i \leq 23V$
$V_D$	Dropout Voltage		2		V	$I_o=1A$ , $T_J=25$
$R_o$	Output Resistance		17		m	$f=1kHz$
$I_{SC}$	Short Circuit Current		250		mA	$V_i=35V$ , $T_A=25$
$I_{PK}$	Peak Current		2.2		A	$T_J=25$



## Typical Applications

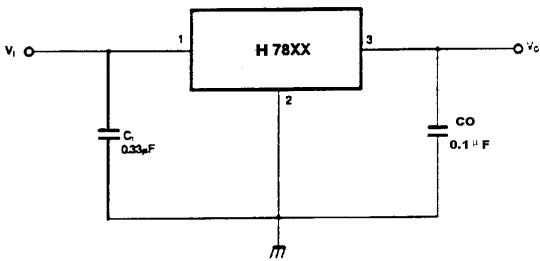

1、 DC Parameters

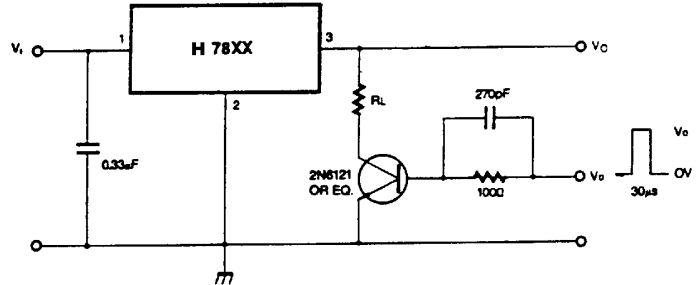

2、 Load Regulation

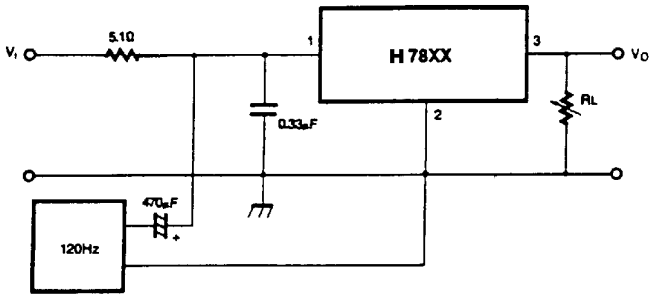

3、 Ripple Rejection

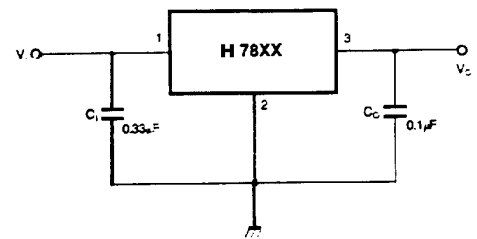

4、 Fixed Output Regulator

### Notes:

- (1) To specify an output voltage, substitute voltage value for "XX." A common ground is required between the input and the Output voltage. The input voltage must remain typically 2.0V above the output voltage even during the low point on the input ripple voltage.
- (2)  $C_1$  is required if regulator is located an appreciable distance from power Supply filter.
- (3)  $C_0$  improves stability and transient response.

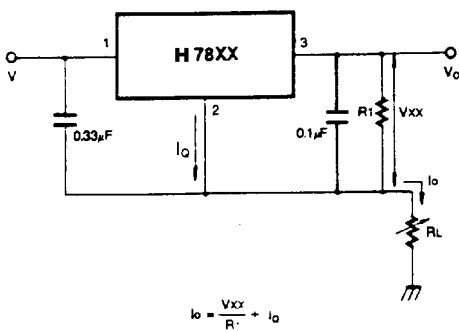

5、 Constant Current Regulator

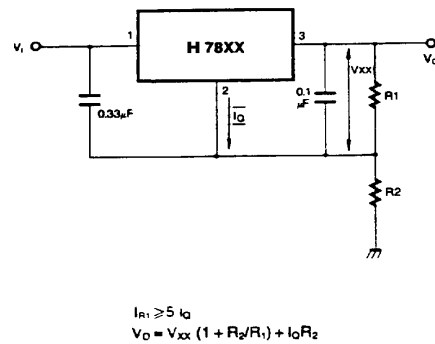

6、 Circuit for Increasing Output Voltage



# H 7809A

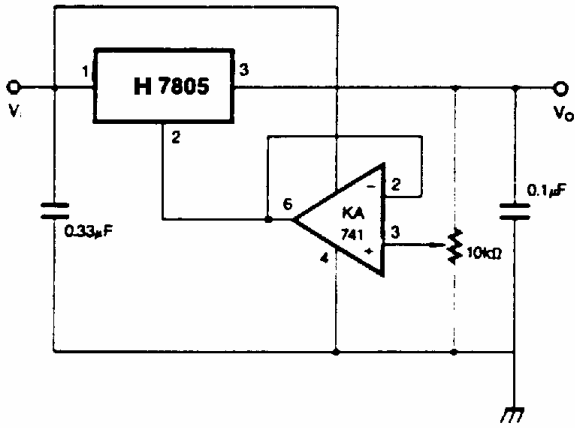

7、Adjustable Output Regulator (7 to 30V)

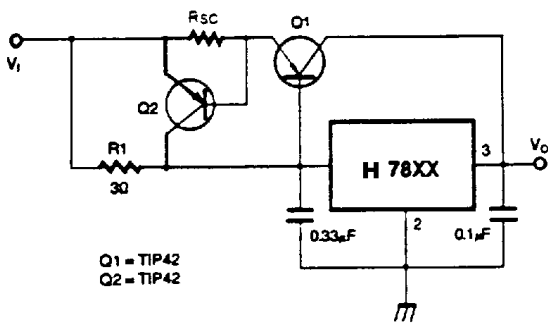

9、High Output Current with Short Circuit Protection

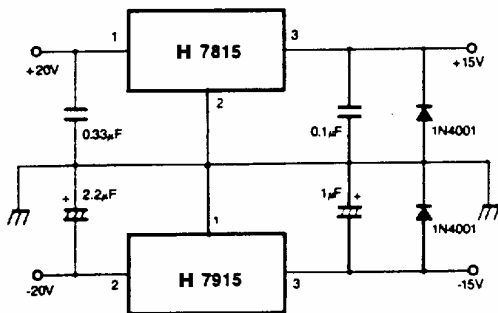

11、Split Power Supply (±15V-1A)

8、High Current Voltage Regulator

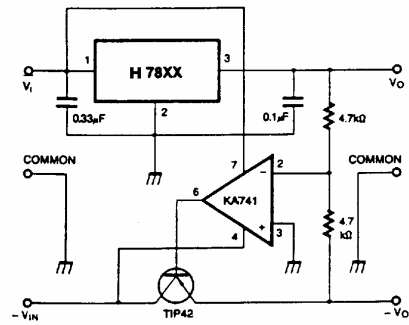

10、Tracking Voltage Regulator

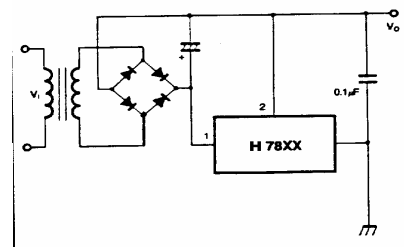

12、Negative Output Voltage Circuit

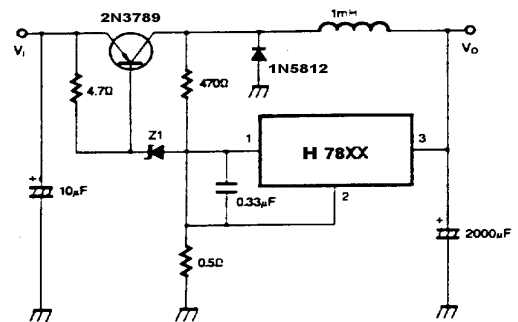

13、Switching Regulator



## Typical Performance Characteristics

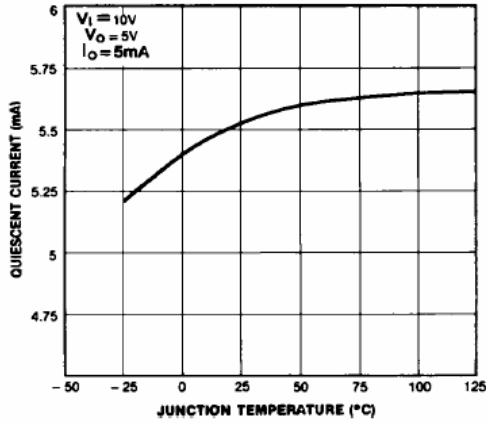

Figure 1. Quiescent Current

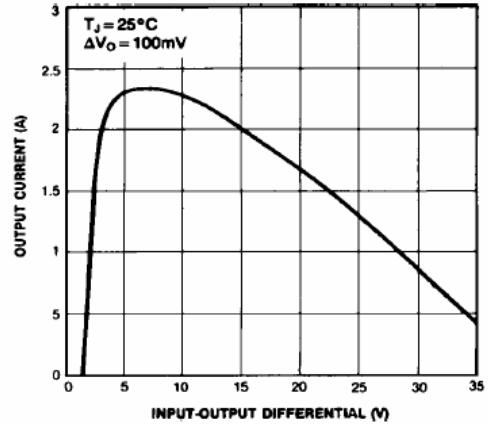

Figure 2. Peak Output Current

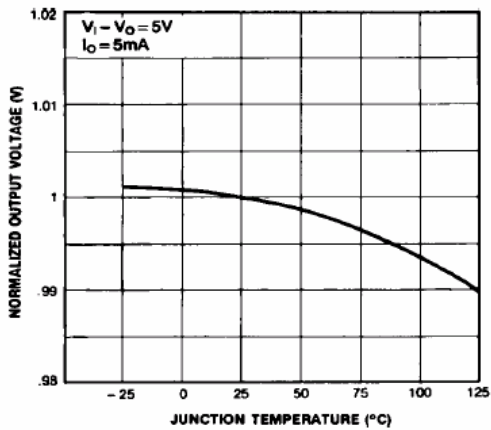

Figure 3. Output Voltage

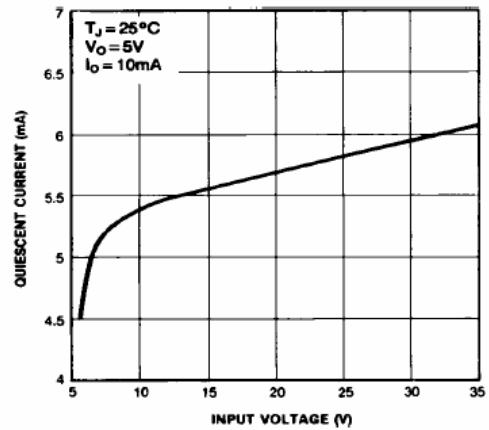

Figure 4. Quiescent Current